

The DPHA series is a dual-polarization antenna specialized for the corresponding service. It consists of two ports, and LHCP and RHCP polarization are provided depending on the input port. This can be used more easily through the RF Switch.

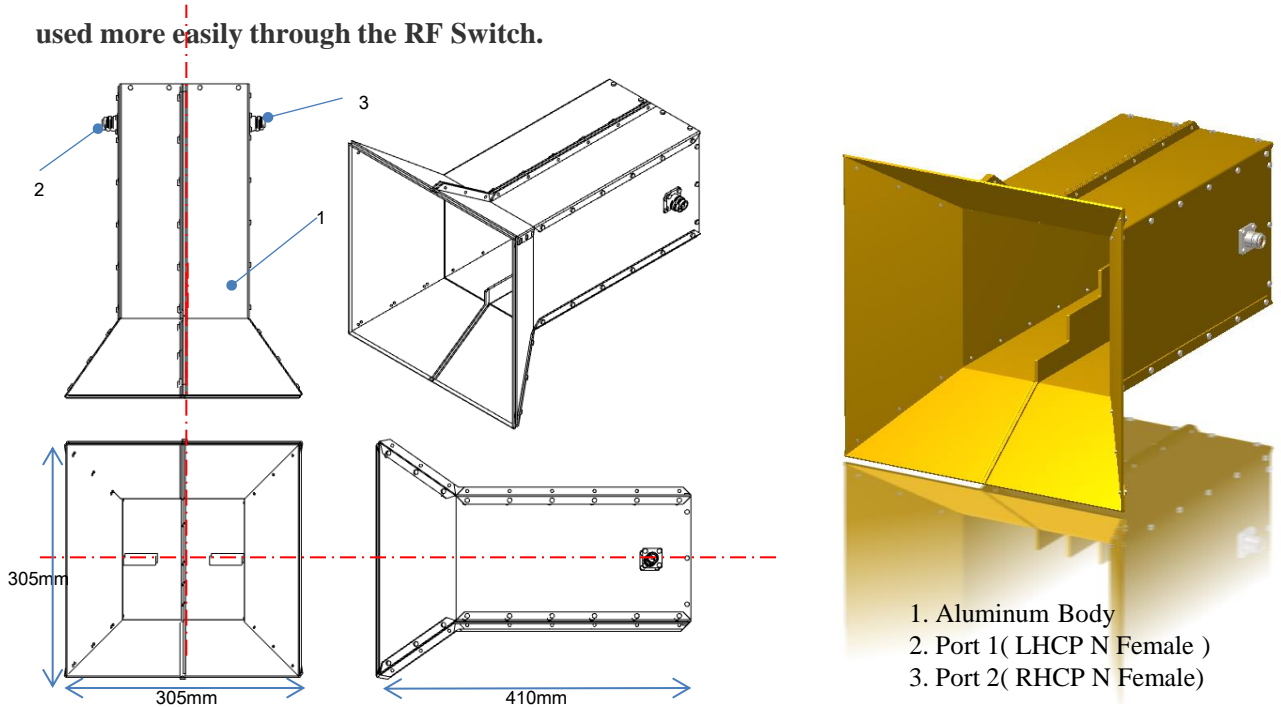

■ Electrical/Physical Characteristics

Category	Item	Specification	Unit	Conditions	
Electrical	Frequency	1.165 ~ 1.610	GHz typ.		
	Bandwidth	≒ 30	%	@Center Frequency	
	Half Power Beam Width	E-plane	45	°	@Deg.
		H-Plane	45		
	Impedance	50	Ω		
	Input Power	50	W	@Max.	
	Polarization	LHCP & RHCP			
	VSWR	≤ 2.0			
	Axial Ratio	≒ 3	dB	@Min.	
Gain	13 ± 1	dBic			
Physical	Dimension	305 × 305 × 410	mm	@ L × W × H	
	Weight	≤ 8	Kg	@except mount bolt	
	Port	N Female	type	@ 2 Port	

■ VSWR

Tr1 S11 Refl SWR RefLvl: 1.0 Res: 200 mU/Div

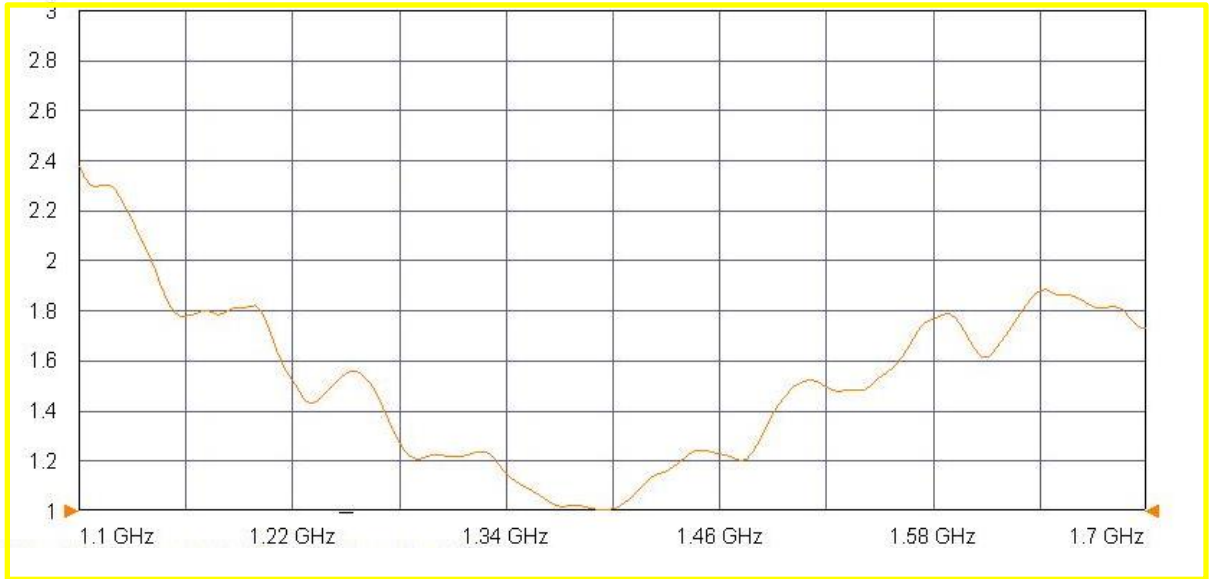

■ Isolation

Tr2 S12 Trans LogM RefLvl: 0 dB Res: 10 dB/Div

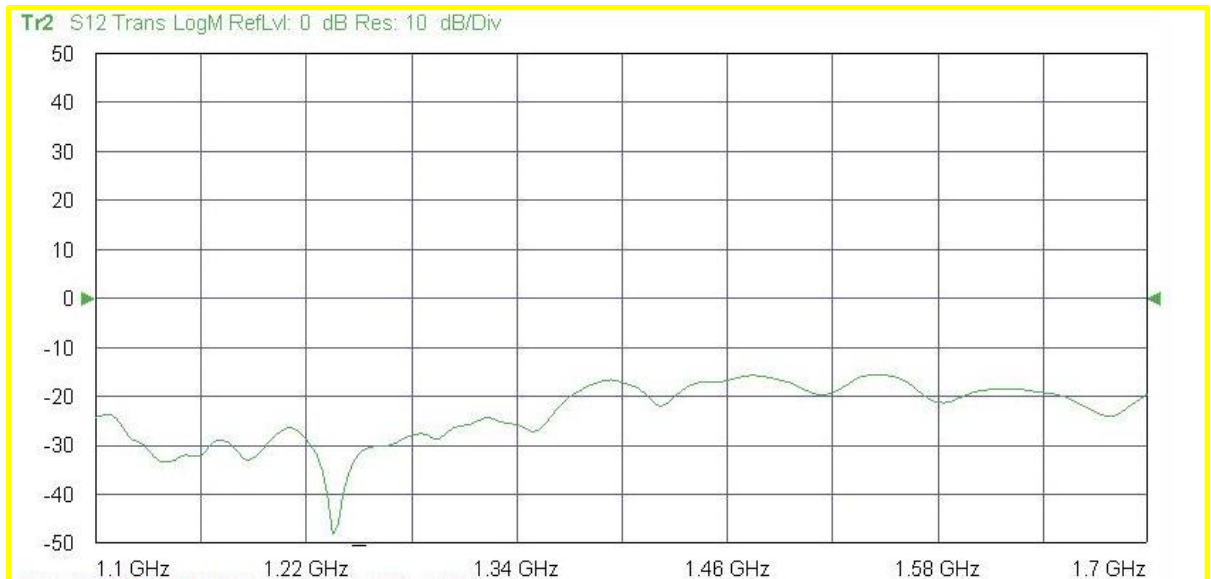

■ Gain – Low Band

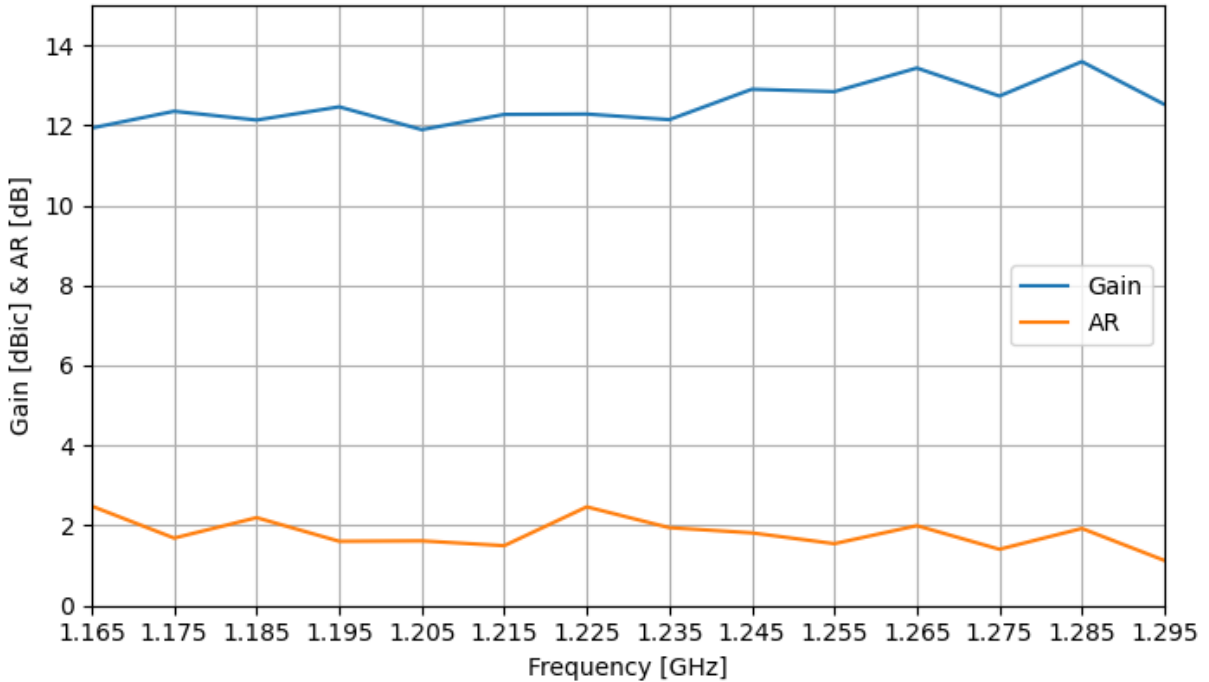

■ Gain – High Band

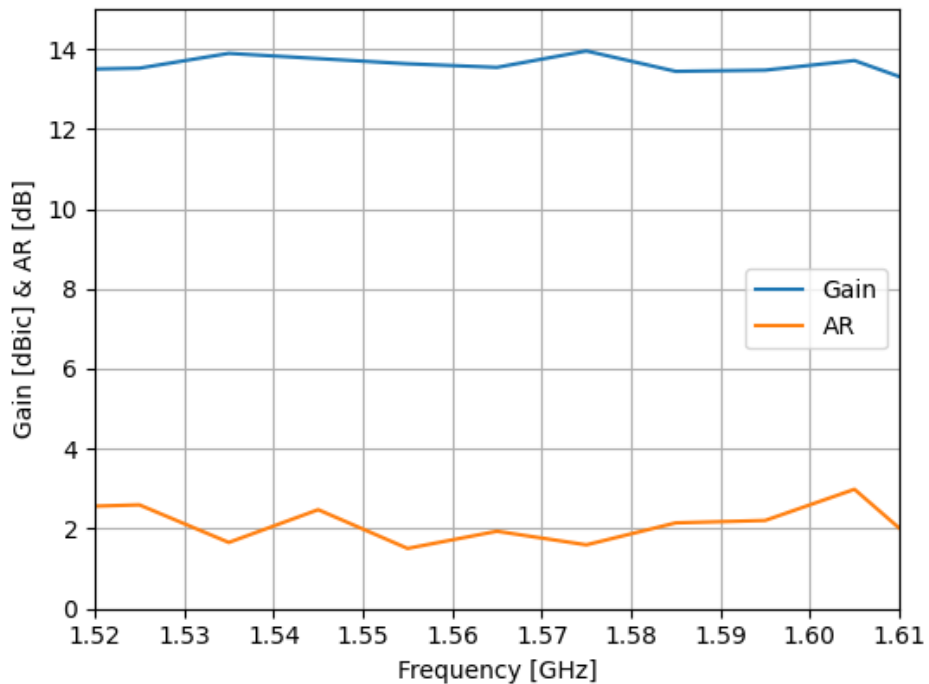

■ Radiation Patterns – RHCP

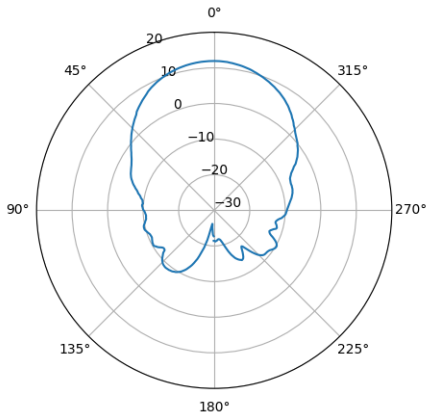

1165 MHz

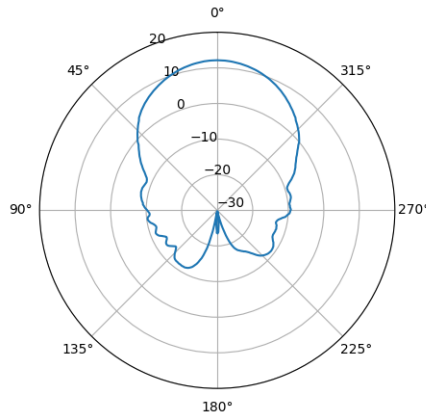

1235 MHz

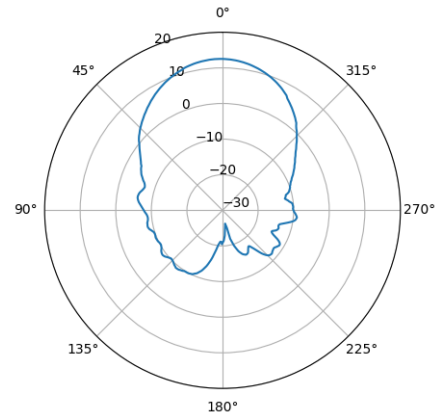

1295 MHz

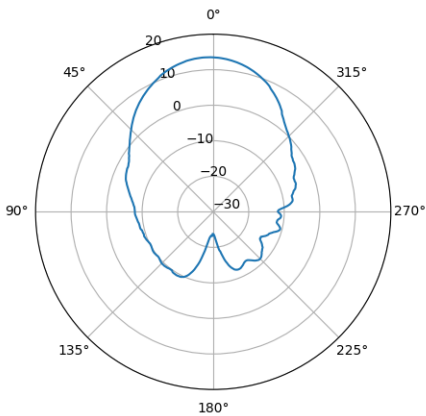

1525 MHz

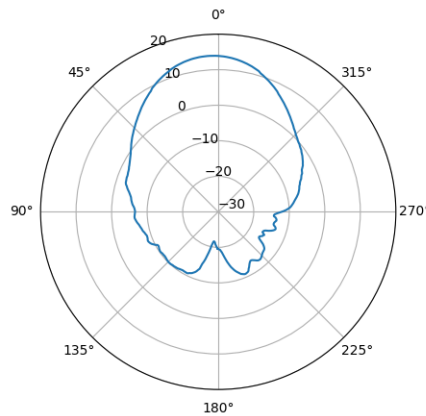

1575 MHz

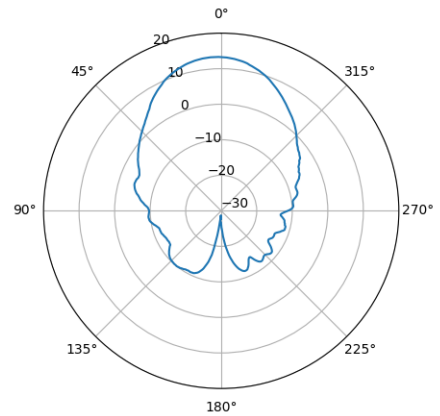

1610 MHz

■ Radiation Patterns – LHCP

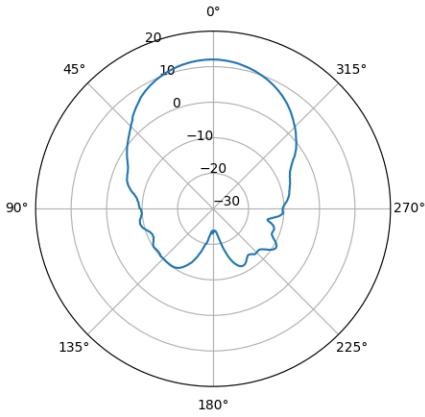

1165 MHz

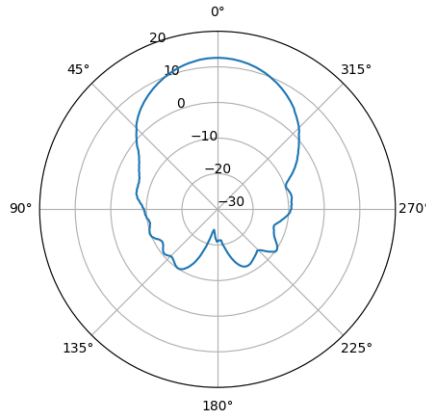

1235 MHz

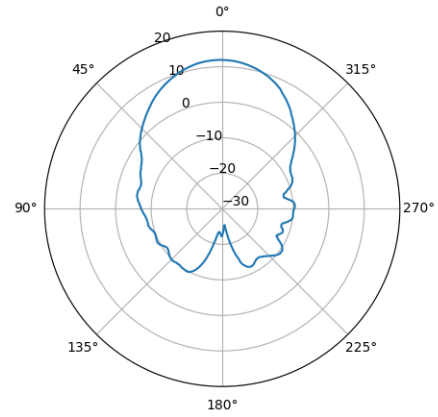

1295 MHz

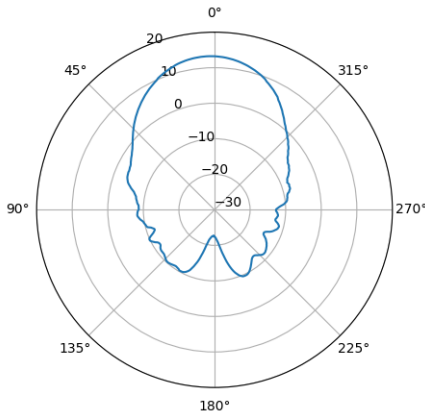

1525 MHz

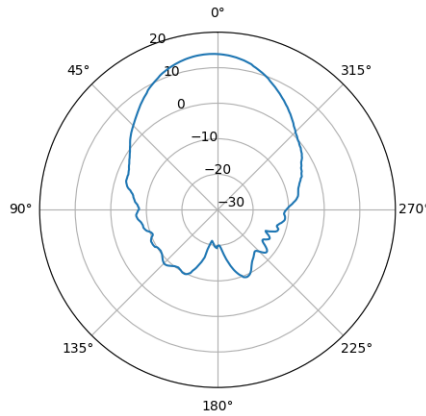

1575 MHz

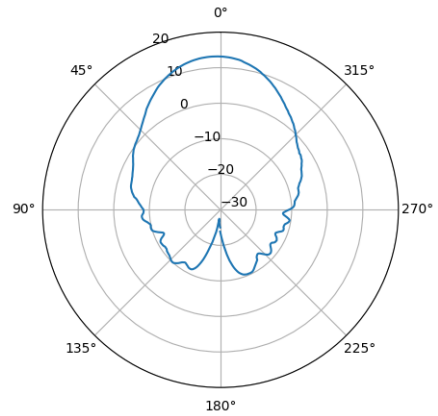

1610 MHz